

# RMOD4000-EW Series / Plug & Play Mobility

## 4000W / Extra-Wide Input 180-950VDC

### FEATURES

- High voltage DC/DC converter for E-Mobility
- Covering input voltage range 180-950VDC
- IP67, IP69, IP69K protection acc. to ISO 20653
- EN62477-1, ISO 6469-3, ECE-R10/100
- CAN J1939 interface
- High power density
- Excellent efficiency
- Base plate cooled or liquid cooled
- 2 years warranty



Dimensions (LxWxH): 316.0 x 254.0 x 83.0mm (12.44 x 10 x 3.27 inch)  
6500g (14.33 lbs)

### APPLICATIONS



### SAFETY & EMC



### DESCRIPTION

The RMOD high voltage families are On-Board DC/DC converter to generate the low voltage network (12/24V) from the vehicle's high voltage traction battery. The units are extremely robust plug & play modules and operates reliably even under the most adverse conditions. The ultra-wide input voltage range from 180V to 950VDC covers all battery voltages from nominal 250V up to 800V, which are commonly used in On- and Off-highway vehicles. Thanks to the excellent efficiency the unit is extremely compact and easy to implement via CAN-Interface to the vehicles Control-Network. The housing construction is waterproof and dust proof and the devices runs with base plate cooling or with water cooling. This solution is ideal for HV-battery powered electric vehicles "On- and Off-Highway E-Mobility Applications" such as Material Handling, Forklift trucks, Golf cars, AGVs, Loaders, Construction vehicles, Airport equipment, People mover, Special vehicles, Transporters, Tractors, etc.

### SELECTION GUIDE

Part Number	Input Voltage Range [VDC]	Output Voltage nom. [VDC]	Output Current max. <sup>(1)</sup> [A]	Efficiency typ. <sup>(2)</sup> [%]	Output Power max. <sup>(1)</sup> [W]
RMOD4000-650-14SEW	180-950	14	180	91	2500
RMOD4000-650-28SEW	180-950	28	150	94	4200

Note1: refer to „Input Voltage Range“ Maximum P<sub>OUT</sub> at V<sub>IN</sub>= 400-850VDC (28Vout); V<sub>IN</sub>= 250-950VDC (14Vout)

Note2: Efficiency is tested at nominal input and 50%-100%, +25°C ambient

### MODEL NUMBERING

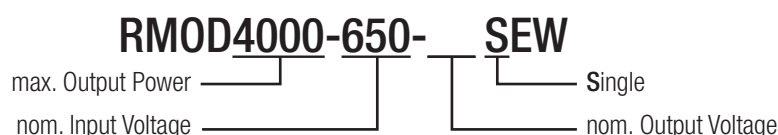

**BASIC CHARACTERISTICS** (measured @  $T_{AMB}= 25^{\circ}C$ , nom.  $V_{IN}$ , full load and after warm-up unless otherwise stated)

Parameter	Conditions		Min.	Typ.	Max.
Input Voltage Range	nom. $V_{IN}= 300/450/650/800VDC$		180VDC <sup>(3)</sup>		950VDC
Input Capacitance	internal			7 $\mu$ F	
Under Voltage Lockout			180VDC		
Input Current	$V_{IN}=180VDC$			12A	
	$V_{IN}= 650VDC$			6.5A	
	$V_{IN}= 950VDC$			3.3A	
Inrush Current	active inrush current limitation				26.5A
No Load Power Consumption	$V_{IN}= 250VDC$			28.5W	
	$V_{IN}= 900VDC$			23.4W	
Standby Current (shutdown by remote)	$V_{IN}= 180VDC$				24.3W
	$V_{IN}= 650VDC$				24W
	$V_{IN}= 950VDC$				24.4W
Output Current Range	unit is equipped with an automatic/active current limitation in dependance of the input voltage	RMOD4000-650-28SEW	$V_{IN}= 180-250VDC$		78A
			$V_{IN}= 251-300VDC$		115A
		RMOD4000-650-14SEW	$V_{IN}= 301-850VDC$		150A
			$V_{IN}= >850VDC$		115A
			$V_{IN}= 180-250VDC$		140A
			$V_{IN}= 251-950VDC$		180A
Output Voltage Range	RMOD4000-650-14SEW		9VDC	12VC	14VDC
	RMOD4000-650-28SEW		18VDC	24VDC	28VDC
Minimum Load			0%		
Start-up time	input voltage applied, by interface enabled	$V_{IN}= 200VDC$			4.6s
		$V_{IN}= 950VDC$			3.5s
Rise time	input voltage is applied, by using the CAN command				TBD
Rise time	nom. $V_{IN}= 650VDC$			TBD	
ON/OFF CTRL	enable/disable Hardware contact	DC-DC ON (input voltage applied)	KL15 >9VDC, unit can be turned ON by CAN command or if it's running Unit ON		
		DC-DC OFF (input voltage applied)	KL15 <4.5VDC, unit cannot be turned ON by CAN command, or if it's running unit turns OFF		
Internal Operating Frequency	first stage			65kHz	
	second stage			75kHz	
Output Ripple and Noise	over full input and load range, 20MHz BW				5%p-p

Note3: Start-up voltage= 200VDC; after run-up, operation until 180VDC

### Input Voltage Range (Line Derating)

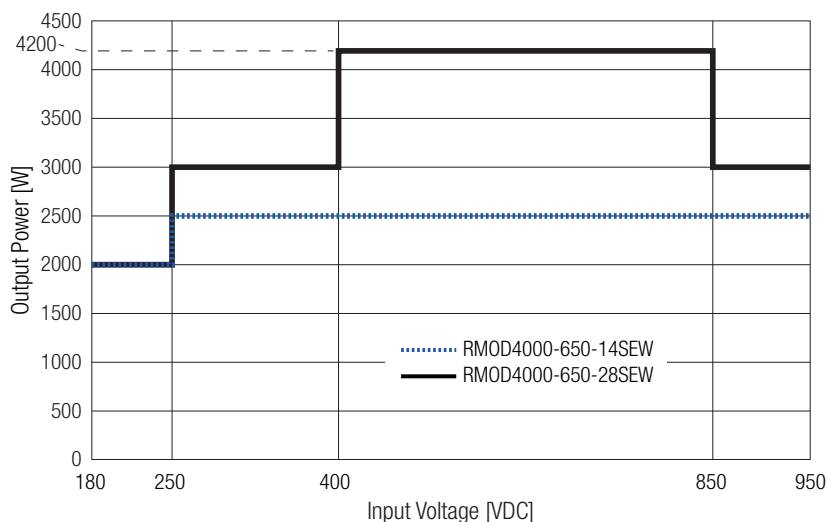

**BASIC CHARACTERISTICS** (measured @  $T_{AMB} = 25^{\circ}C$ , nom.  $V_{IN}$ , full load and after warm-up unless otherwise stated)

### Input Current Consumption

(RMOD4000-650-28SEW)

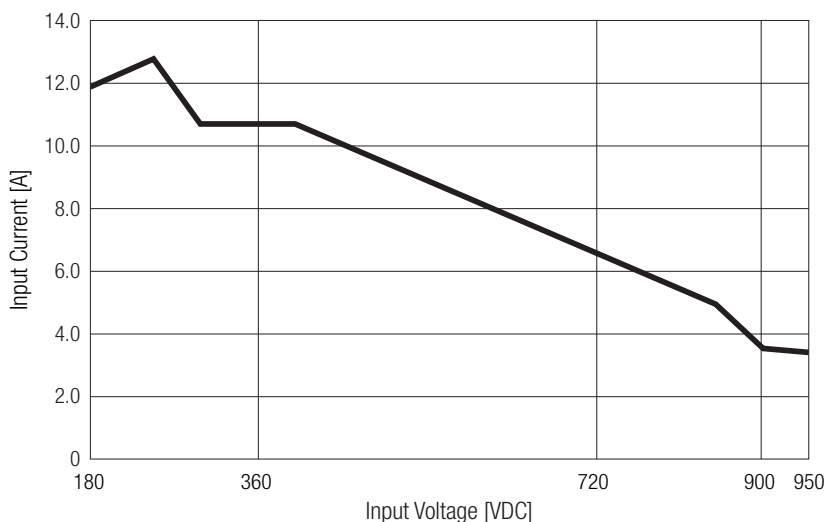

### Efficiency vs Load

RMOD4000-650-14SEW

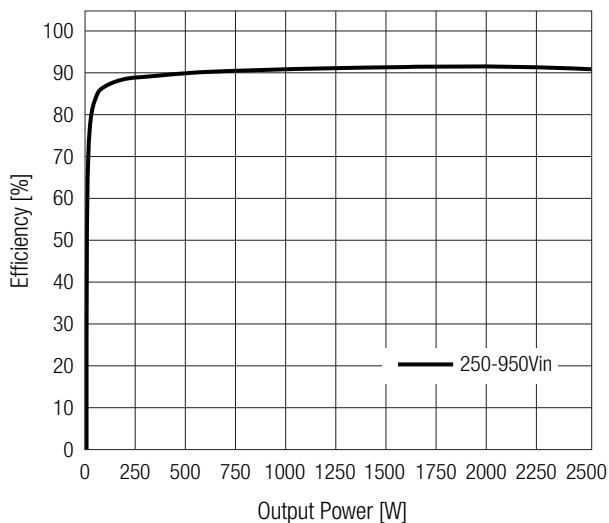

RMOD4000-650-28SEW

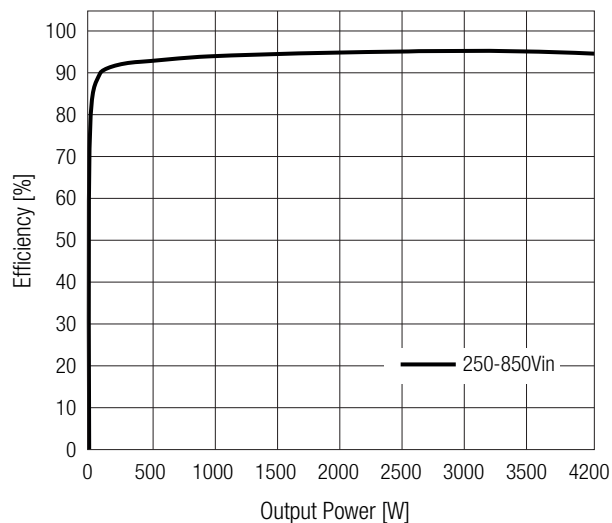

**REGULATIONS** (measured @  $T_{AMB} = 25^{\circ}C$ , nom.  $V_{IN}$ , full load and after warm-up unless otherwise stated)

Parameter	Conditions		Value
Output Accuracy	manufacturing set-up tolerance		$\pm 2.0\%$ typ.
Line and Load Regulation	low line to high line, 10-100% load		$\pm 3.0\%$ typ.
Transient Response	10-90% load	RMOD4000-650-28SEW	840mV
		RMOD4000-650-14SEW	420mV
	recovery time		50ms typ.

# RMOD4000-EW Series / Plug & Play Mobility

## 4000W / Extra-Wide Input 180-950VDC

### PROTECTIONS (measured @ $T_{AMB}=25^{\circ}\text{C}$ , nom. $V_{IN}$ , full load and after warm-up unless otherwise stated)

Parameter	Type		Value
Internal Input Fuse			none <sup>(4)</sup>
Input Discharge Duration	$\leq 60\text{VDC}$		5s max.
Short Circuit Protection (SCP)	constant current mode, auto recovery		35% of nom. $V_{out}$
	hiccup mode, auto recovery		$\leq 35\%$ of nom $V_{out}$
Input Reverse Polarity Protection	mechanical protection		by connector
Over Voltage Protection (OVP)	latch off, auto recovery	RMOD4000-650-28SEW	30VDC max.
		RMOD4000-650-14SEW	15.3VDC max.
Over Voltage Category (OVC)			OVC I
Over Current Protection (OCP)	constant current mode, auto recovery		35% of nom. $V_{out}$
	hiccup mode, auto recovery		$< 35\%$ of nom $V_{out}$
Over Temperature Protection (OTP)	internal threshold by NTC, auto restart after cool down		$T_J = > 80^{\circ}\text{C}$
Class of Equipment			Class I
Isolation Coordination	according to EN 60664-1		$V_{NOM} = 950\text{VDC}$
Isolation Voltage <sup>(5)</sup>	5 seconds	I/P to O/P + CAN	2100VAC / 3050VDC
		I/P to Case	1050VAC / 1520VDC
		O/P + CAN to Case	80VAC / 110VDC
		O/P to CAN	160VAC / 220VDC
Isolation Resistance	I/P to PE; O/P to PE; 24Aux-PE		1G $\Omega$
Isolation Capacitance	I/P to PE		25nF max.
	O/P to PE		40nF max.
	24Aux to PE		300pF max.
Insulation Grade	I/P to O/P; I/P to 24Aux; O/P to 24Aux		reinforced
	I/P to PE; O/P to PE; 24Aux to PE		basic
Internal Clearance	I/P to O/P; I/P to 24Aux		7mm
	I/P to PE		4mm
	O/P to PE; O/P to 24Aux; 24Aux to PE		2mm
HVIL function	High voltage interlock, safety feature for low-voltage loop		

Note4: No integrated fuse. A fuse must be provided externally by the customer application in accordance with maximum input parameters.

Note5: For repeat Hi-Pot testing, reduce the time and/or the test voltage

### ENVIRONMENTAL (measured @ $T_{AMB}=25^{\circ}\text{C}$ , nom. $V_{IN}$ , full load and after warm-up unless otherwise stated)

Parameter	Conditions		Value
Operating Ambient Temperature Range	with liquid cooling $50^{\circ}\text{C}$ , full load		$-40^{\circ}\text{C}$ to $+85^{\circ}\text{C}$
Maximum Inlet Coolant Temperature	$P_{OUT} \leq 2\text{kW}$		$+60^{\circ}\text{C}$ max.
	$P_{OUT} \geq 2\text{kW}$		$+50^{\circ}\text{C}$ max.
Coolant Medium/Mixture			Min 50% water to max 50% antifreeze
Minimum Coolant Flow			6ltr/min
Maximum Coolant Pressure			1.8bar
Maximum Pressure Drop			0.22bar
Operating Altitude			2000m
Operating Humidity	non-condensing		95% RH max.
Pollution Degree	for inside isolation coordination		PD1
	entire device in IP67 and provided mating connectors		PD4
IP Rating	according to ISO 20653		IP67
MTBF	according to MIL-HDBK-217, G.M.	$T_{AMB} = 25^{\circ}\text{C}$	$75 \times 10^3$ hours
	according to MIL-HDBK-217, G.F.		$160 \times 10^2$ hours

# RMOD4000-EW Series / Plug & Play Mobility

## 4000W / Extra-Wide Input 180-950VDC

### ENVIRONMENTAL

Parameter	Conditions	Value
Low Temperature start-up test	Temperature: -40°C Stabilization time 2h	EN 60068-2-1 (Ad)
Dry heat test	Temperature: +70°C Continuous operational checks time 6h	EN 60068-2-2 (Be) – Cycle A
Low temperature storage test	Temperature: -40°C Low temperature exposition time 16h	EN 60068-2-1 (Ab)
Cyclic damp heat test	Temperature: +70°C/+25°C Number of cycles: 2 Time 2x 24h	EN 60068-2-30 (Db)
Road vehicles - Environmental conditions and testing for electrical and electronic equipment - Mechanical loads ISO 16750-3	sinusoidal (Excitation) 5g (acceleration) 10-500Hz (frequency) 30min per axis (Duration), 1 Oct/min X, Y, Z (Axis)	IEC 60068-2-6, Environmental testing — Part 2: Tests — Test Fc: Vibration (sinusoidal)
	Half sinusoidal (Excitation) 100m/s <sup>2</sup> (Peak acceleration) 16ms (Duration) 6 shocks to each axis (Quantity) ±X, ±Y, ±Z (Axis)	IEC 60068-2-27, Environmental testing — Part 2: Tests — Test Eb and guidance: Bump
	Random (Excitation) 10 (m/s <sup>2</sup> ) <sup>2</sup> /Hz (ASD) 10-50Hz (frequency) 10 to 0.1 (m/s <sup>2</sup> ) <sup>2</sup> /Hz (ASD) 50-1000Hz (frequency) 33 m/s <sup>2</sup> (RMS value acceleration) 8h per axis (Duration), 1 Oct/min X, Y, Z (Axis)	IEC 60068-2-64, Environmental testing — Part 2: Test methods — Test Fh: Vibration, broad-band random

### SAFETY & CERTIFICATIONS (PENDING)

Certificate Type (Safety)	Standard
Safety requirements for power electronic converter systems and equipment - Part 1: General	IEC/EN62477-1
Electrically propelled road vehicles - Safety specifications - Part 3: Electrical safety	ISO6469-3
RoHS2	RoHS 2011/65/EU + AM2015/863

EMC Compliance	Conditions	Standard / Criterion
Approval of vehicles with regard to electromagnetic compatibility	ESA broadband limits applicable parts of the standard 30-75 MHz; 62-54 dBµV/ m 75-400 MHz; 52-65 dBµV/ m 0,4-1 GHz; 63 dBµV/ m	ECE-R10, Rev.4, Part 6.5
	ESA narrowband limits 30-75 MHz; 52-42 dBµV/ m 75-400 MHz; 42-65 dBµV/ m 0,4-1 GHz; 53 dBµV/ m	ECE-R10, Rev.4, Part 6
	Conducted Emissions Tab. / tab 2	ECE-R10, Rev.4, Part 6.9
	Störfestigkeit / Immunity HF-Stromeinspeisung / Bulk Current Injection applicable parts of the standard 0,02 - 2 GHz ; 60 mA	ECE-R10, Rev.4, Part 6.7
Road vehicles - Electrical disturbances from conduction and coupling	Transients test pulse 1, test pulse 2a, test pulse 2b, test pulse 3a/b	ECE R10 ISO 7637-3
Road vehicles - Component test methods for electrical disturbances from narrowband radiated electromagnetic energy		EN ISO 114521

# RMOD4000-EW Series / Plug & Play Mobility

## 4000W / Extra-Wide Input 180-950VDC

### DIMENSION & PHYSICAL CHARACTERISTICS

Parameter	Type	Value
Material	case	aluminum
Dimension (LxWxH)	without connectors	316.0 x 254.0 x 83.0mm 12.44 x 10 x 3.27 inch
Weight		6500g typ. 14.33 lbs

Dimension Drawing (mm)

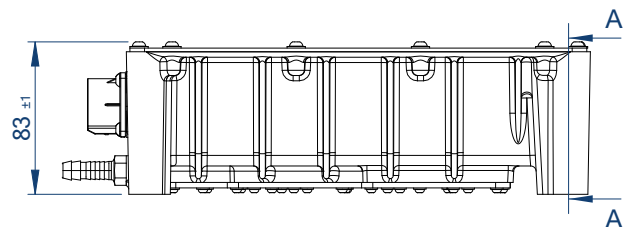
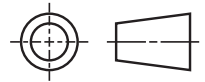
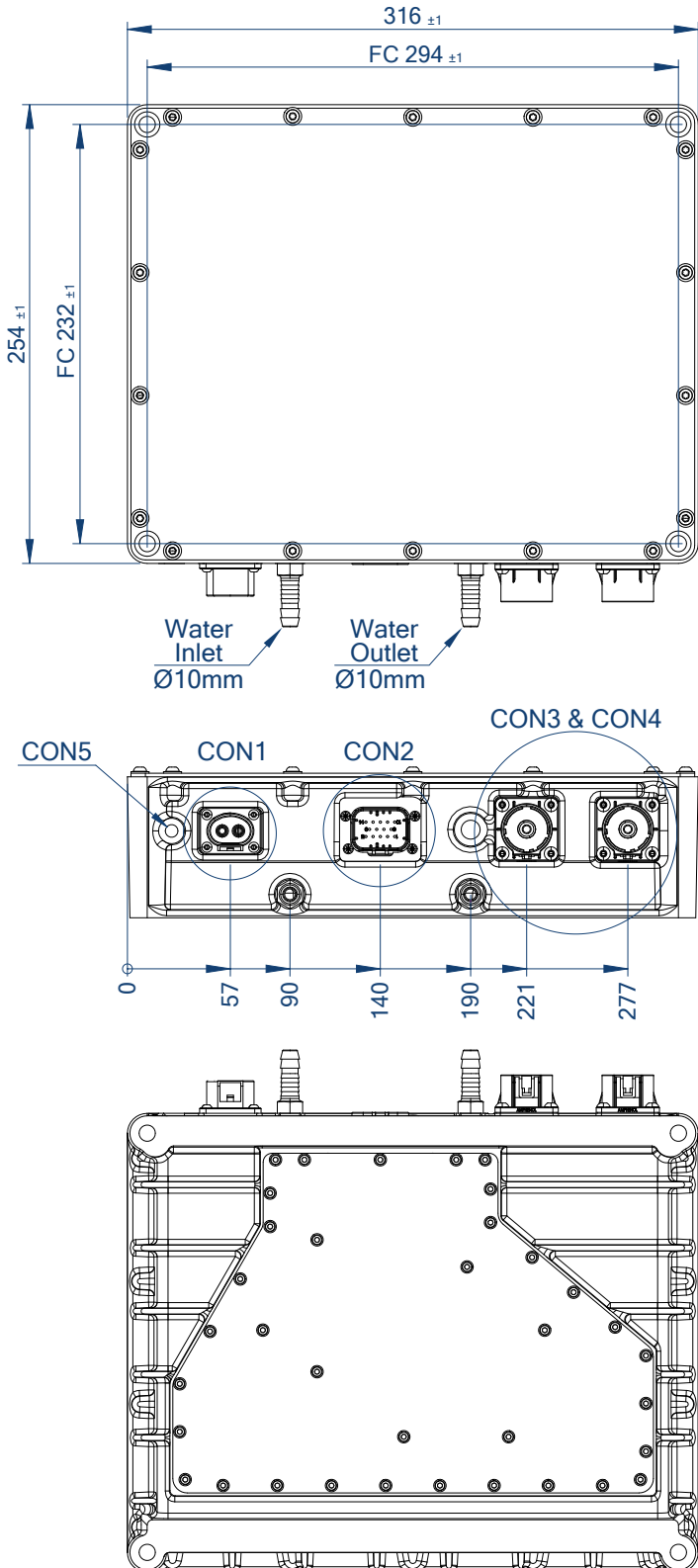

Section A-A

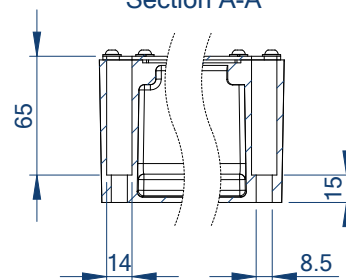

Tolerance Table	
Dimension range	Tolerances
0.5 - 6 mm	±0.1 mm
6 - 30 mm	±0.2 mm
30 - 120 mm	±0.3 mm
120 - 315 mm	±0.5 mm

FC = fixing centers

### DIMENSION & PHYSICAL CHARACTERISTICS

**DETAIL CON1**  
SCALE 1 : 1

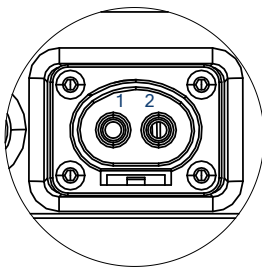

**DETAIL CON2**  
Scale 1:1

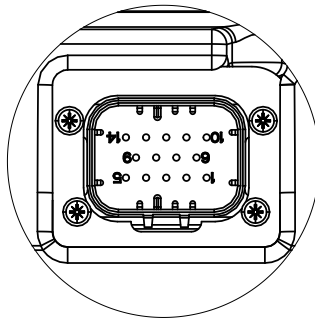

**DETAIL CON3 & CON4**  
SCALE 1 : 3

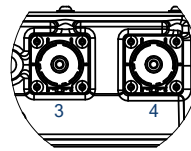

**DETAIL CON5**  
Scale 1:1

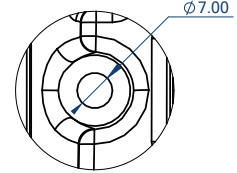

**Input connector CON1**  
(Amphenol PL082X-61-4)

#	Function	Wire diameter
1	+Vin	3-4mm <sup>2</sup>
2	-Vin	3-4mm <sup>2</sup>

Compatible Connector:  
Amphenol PL182X-61-4

**Output connector CON3 & CON4**  
(2x Amphenol PL00Y-300-20M8)

#	Function	Wire diameter
3	-Vout	30-50mm <sup>2</sup>
4	+Vout	30-50mm <sup>2</sup>

Compatible Connector:  
CON3= Amphenol PL18Y-300-50  
CON4= Amphenol PL18W-300-50

**Signal CON2**  
(TE connectivity 1-776267-1)

#	Function
1	Interlock (HVIL)
2	Interlock (HVIL)
3	K15 (Ignition switch position)
4	K30 (Vaux positive)
5	K31 (Vaux negative)
6	I/O signal (Optionals)
7	I/O signal (Optionals)
8	I/O signal (Optionals)
9	I/O signal (Optionals)
10	NC
11	CANH
12	CANL
13	CANH
14	120 Ohm resistor (with short circuit between pin 13-14)

Wire Diameter: 20AWG-16AWG

**PE connector CON5**  
(M8 thread)

#	Function
5	M8 thread

**Signal CON2**

**Compatible Connector**

TE Connectivity 776273-1 Housing  
12 contacts 770854-3

In some applications the presence and correct fixing of input connector must be ensured before start up the unit. To realize this function KL15 (Pin 3) can be connected in series with HVIL pins (Pin 1/2). In that way the converter will be in disable status until the input cable connection will be present. The following picture shows the connection described:

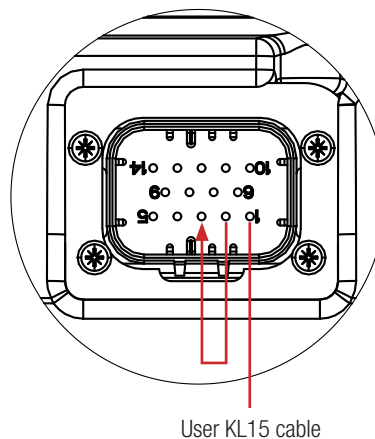

### INSTALLATION & APPLICATION

#### Parallel Operation

Here the example of three parallel connected units. The connection of 3 units for power redundant or safety redundant or n+1 redundancy is possible. Parallel operation is possible due to implemented OR-ing Diode. Programmable current sharing via CAN communication.

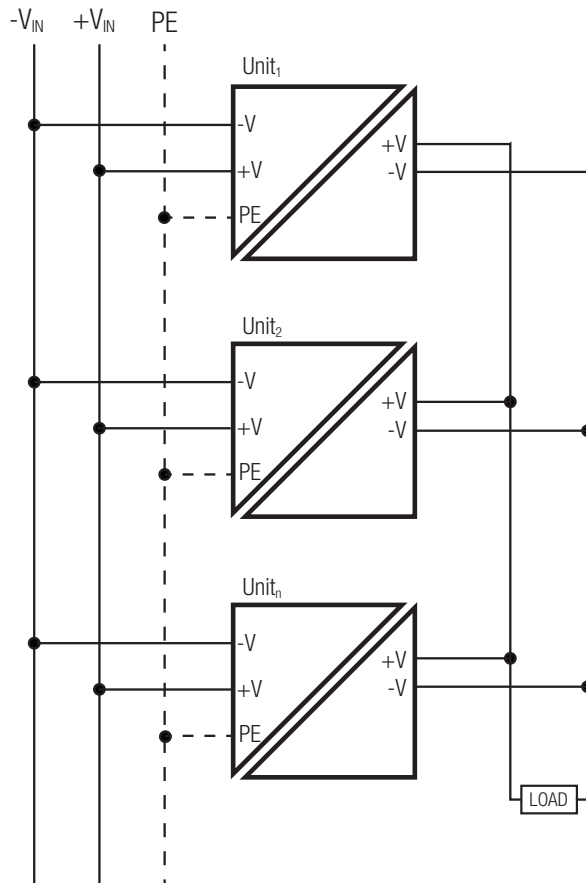

### CAN BUS (Interface acc. to ISO 11898-1 J1939)

Parameter	
Status	refer to: „Can Bus PGNs/SPNs for commands“ and „Can Bus PGNs/SPNs for reading and diagnostic“
Input Voltage	
Input Current	
Output Voltage	
Output Current	
Temperature	
Input Voltage-current characteristic	
Output voltage level	
Threshold values	
Termination Resistor Connection	The ISO11898 standard specifies the interconnect to be a single twisted pair cable (shielded or unshielded) with 120Ω characteristic impedance (Z0). User can realize the termination with a short circuit between pins 13 and 14 of signals/Can Bus connectors.



# RMOD4000-EW Series / Plug & Play Mobility

## 4000W / Extra-Wide Input 180-950VDC



### CAN BUS PGNs/SPNs for commands

PGN	SPN	Name	Signal Name	Length	Scaling	Offset	Factor	From	To	Unit	Start bit	Default value	Min Range	Max Range
F112 (61714)	8560	ON/OFF	ON/OFF	4 bits	16 Status	0		0	15		1 1	OFF	OFF	ON
F112 (61714)	9515	Vout_set	Output voltage setting	2 bytes	0.05V per bit	0	0.01	0	642.55	V	6 1	14 28	12 24	14 28
FBD9 (64473)	8566	OutLV	Output undervoltage	2 bytes	0.01V per bit	0	0.01	0	642.55	V	1 1	10 22	10 22	14 28
FBD9 (64473)	8567	OutHV	Output overvoltage	2 bytes	0.01V per bit	0	0.01	0	642.55	V	3 1	14 28	10 22	14 28
FBD9 (64473)	8568	OutOC	Output Overcurrent	2 bytes	0.05V per bit	0	0.05	0	3212.8	A	5 1	180 150	0 0	180 150
FBDA (64474)	8563	InLV	Input undervoltage	2 bytes	0.05V per bit	0	0.05	0	3212.8	V	1 1	180	180	950
FBDA (64474)	8564	InOV	Input overvoltage	2 bytes	0.05V per bit	0	0.05	0	3212.8	V	1 1	180	180	950

### CAN BUS PGNs/SPNs for reading and diagnostic

PGN	SPN	Name	Signal Name	Length	Scaling	Offset	Factor	From	To	Unit	Start bit	Tx rate
F114 (61716)	8585	Vout_M	Output voltage measure	2 bytes	0.01 V per bit	0	0.01	0	642.55	V	1.1	100 ms
F114 (61716)	8586	Iout_M	Output current measure		0.01 A per bit	-3 212.7	0.1	-3 212.7	3212.8	A	3.1	100 ms
F114 (61716)	8587	Vin_M	Output Voltage		0.05 V per bit	0	0.05	0	3212.75	V	5.1	100 ms
F113 (61715)	8569	Status	Public state	4bit							Byte 0 bit 0-3	100 ms
F113 (61715)	8573	OVC/OVP	Overcurrent/Overvoltage flag	2bit							Byte 1 bit 2-3	100 ms
F113 (61715)	8574	VIN_LV	Input undervoltage flag	2bit							Byte 1 bite 4-5	100 ms
F113 (61715)	8575	VIN_HV	Input overvoltage flag	2bit							Byte 1 bite 6-7	100 ms
F113 (61715)	8576	Vo_LV	Output undervoltage flag	2bit							Byte 2 bit0-1	100 ms
F113 (61715)	8577	Vo_HV	Output overvoltage flag	2bit							Byte 2 bit2-3	100 ms
F113 (61715)	8578	OVT-2	Secondary side Overtemperature flag	2bit							Byte2 bit4-5	100 ms
F113 (61715)	8580	OVT-1	Primary side Overtemperature flag	2bit							Byte3 bit0-1	100 ms
FBD8 (64472)	8594	Temp-2	Secondary side internal temperature	1 Byte	1°C per bit	-40	1	-40	210	°C	3 1	1s
FBD8 (64472)	8592	Temp-1	Primary side internal temperature	1 Byte	1°C per bit	-40	1	-40	210	°C	1 1	1s

### PACKAGING INFORMATION

Parameter	Type	Value
Packaging Dimension (LxWxH)	cardboard box	TBD
Packaging Quantity		TBD
Storage Temperature Range		-40°C to +85°C

The product information and specifications may be subject to changes even without prior written notice. The product has been designed for various applications; its suitability lies in the responsibility of each customer. The products are not authorized for use in safety-critical applications without RECOM's explicit written consent. A safety-critical application is an application where a failure may reasonably be expected to endanger or cause loss of life, inflict bodily harm or damage property. The applicant shall indemnify and hold harmless RECOM, its affiliated companies and its representatives against any damage claims in connection with the unauthorized use of RECOM products in such safety-critical applications.