

RPZ-0.5 Series / Power Module

0.5 Amp / 2.3-5.5VDC / 10 Pad QFN Package

FEATURES

- 2.3-5.5VDC input range
- Low profile 1.6mm
- Ultra-compact footprint 2x2mm
- Adjustable output 0.6 to 5.375V
- 0.5A output current
- Up to 115°C ambient temperature at full load
- Integrated solution
- 3 year warranty



Dimensions (LxWxH): 2.0 x 2.0 x 1.6mm (0.079 x 0.079 x 0.063inch)
0.1g (0.0002lbs)

APPLICATIONS



SAFETY & EMC



DESCRIPTION

The RPZ-0.5 is a synchronous buck converter with integrated inductor in a tiny 2.0mm x 2.0mm x 1.6mm thermally-enhanced QFN package. The input range is from 2.3 to 5.5VDC. The output voltage can be set with two resistors in the range from 0.6V up to 5.375V. The output current is up to 500mA and is fully protected against continuous short-circuits, output overcurrent, or over-temperature faults. Its high current and small size make the RPZ-0.5 ideal for imaging systems, distributed power architectures, optical modules, and portable battery-powered equipment in telecom as well as industrial applications.

SELECTION GUIDE

Part Number	Input Voltage	Output Voltage	Output Current	Efficiency ⁽¹⁾
	Range [VDC]	Range [VDC]	max. [mA]	typ. [%]
RPZ-0.5	2.3 - 5.5	0.6 - 5.375	500	88

Note1: Efficiency is tested at $V_{IN} = 5VDC$, $V_{OUT} = 3.3VDC$ full load at +25°C ambient

MODEL NUMBERING

RPZ-0.5- _____
 Output Current Packaging ⁽²⁾

Note2: Add suffix "-R" for tape and reel packaging
 Add suffix "-CT" for bag packaging (refer to „Packaging information“)

RPZ-0.5 Series / Power Module

0.5 Amp / 2.3-5.5VDC / 10 Pad QFN Package

ABSOLUTE MAXIMUM RATINGS

Parameter	Symbol	Condition	Min.	Typ.	Max.
Absolute maximum voltage	V_{IN}				6VDC
		others	-0.3VDC		6VDC
Maximum continuous power losses ⁽³⁾		$T_{AMB} = +25^{\circ}C$			1.6W
Junction Temperature	T_J				+150°C
Lead Temperature					+260°C

Note3: Exceeding maximum allowable power dissipation causes device to enter thermal shutdown which protects device from permanent damage.

BASIC CHARACTERISTICS (measured @ $T_{AMB} = 25^{\circ}C$, nom. V_{IN} , full load and after warm-up unless otherwise stated)

Parameter	Symbol	Condition	Min.	Typ.	Max.
Input Voltage Range	V_{IN}	refer to „Safe Operating Area“	2.3VDC		5.5VDC
Under Voltage Lockout UVLO				2VDC	2.25VDC
Under Voltage Lockout Hysteresis				150mV	
Quiescent current	I_Q	$V_{IN} = 3.6VDC, V_{CTRL} = 2VDC, V_{FB} = 0.63VDC$		340µA	400µA
Output Voltage Range	V_{OUT}	refer to „Safe Operating Area“	0.6VDC		5.375VDC
Output Current Range	I_{OUT}		0mA		500mA
Standby current	I_{IN}	$V_{CTRL} = 0VDC, T_J = 25^{\circ}C$		0µA	1µA
Feedback voltage	V_{FB}	$2.3VDC \leq V_{IN} \leq 5.5VDC, T_J = 25^{\circ}C$	594mV	600mV	606mV
		$T_J = -40^{\circ}C$ to $+125^{\circ}C$	588mV	600mV	612mV
Feedback current	I_{FB}	$V_{FB} = 0.63VDC$		50nA	100nA
High side RDS (on)				130mΩ	
Low side RDS (on)				100mΩ	
High side MosFet peak current limit			1.4A	1.7A	
Dropout resistance	R_{DR}	100% on duty		250mΩ	
Minimum On Time				60ns	
Minimum Off Time				60ns	
Soft Start		V_{OUT} from 10% to 90%		0.5ms	
Output discharge resistor	R_{DIS}	$V_{CTRL} = 0VDC, V_{OUT} = 1.2VDC$		1kΩ	
Output inductor	L	Test frequency 1MHz		0.47µH	
	DCR			0.1Ω	

Typical Application

$V_{IN} = 2.3-5.5VDC, V_{OUT} = 1.2VDC, I_{OUT} = 0.5A$

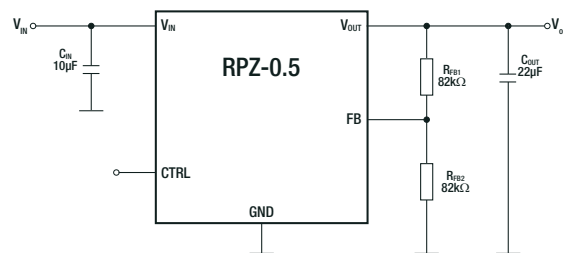

Safe Operating Area

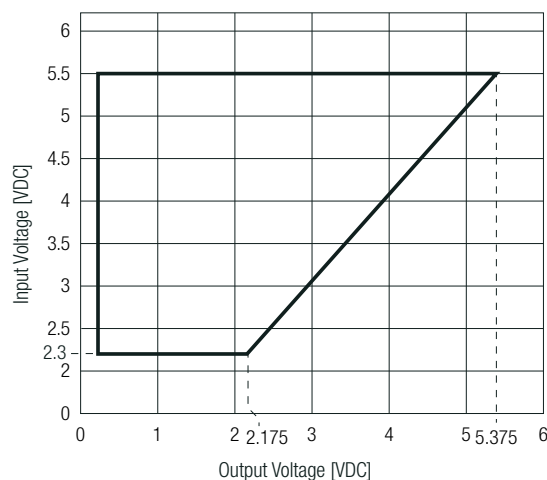

RPZ-0.5 Series / Power Module

0.5 Amp / 2.3-5.5VDC / 10 Pad QFN Package



CTRL OPERATING CONDITIONS

Parameter	Condition	Min.	Typ.	Max.
CTRL input logic low voltage				0.4VDC
CTRL input logic high voltage		1.2VDC		
CTRL input current	$V_{CTRL} = 2VDC$		1.2 μ A	
	$V_{CTRL} = 0VDC$		0 μ A	

SWITCHING CHARACTERISTICS

Parameter	Symbol	Condition	Min.	Typ.	Max.
Switching frequency	f_{SW}	$V_{OUT} = 1.2VDC, I_{OUT} = 500mA, T_J = 25^\circ C$	1920kHz	2400kHz	2910kHz
		$V_{OUT} = 1.2VDC, I_{OUT} = 500mA, T_J = -40^\circ C \text{ to } +125^\circ C$	1800kHz	2400kHz	3000kHz
Switch leakage	V_{SW}	$V_{CTRL} = 0VDC, T_J = 25^\circ C$		0 μ A	1 μ A

PROTECTIONS

Parameter	Condition	Value	
Short Circuit Protection SCP		hiccup, auto recovery	
Over Current Protection OCP		hiccup, auto recovery	
Thermal shutdown	restart after cooldown	junction temperature	160 $^\circ$ C typ.
		hysteresis	30 $^\circ$ C typ.

THERMAL OPERATING CONDITIONS (measured @ $T_{AMB} = 25^\circ C$, nom. V_{IN} , full load and after warm-up unless otherwise stated)

Parameter	Symbol	Condition	Min.	Typ.	Max.
Operating Junction Temperature	T_J	refer to „Thermal Derating“	-40 $^\circ$ C		+125 $^\circ$ C
Thermal Resistance ⁽⁴⁾	R_{thJA}	junction to ambient		70K/W	
	R_{thJC}	junction to case		34K/W	

Note4: Test PCB= 6.4 x 6.4cm double sided PCB with 20oz copper, natural convection

ENVIRONMENTAL

Parameter	Condition	Value
Moisture Sensitive Level		Level 3, 245 $^\circ$ C, 168hrs

RPZ-0.5 Series / Power Module

0.5 Amp / 2.3-5.5VDC / 10 Pad QFN Package

OUTPUT VOLTAGE SETTING

The RPZ-0.5 series offers the feature of trimming the output voltage by using external trim resistors (see „**Typical Application**“). Select the feedback resistor (R_{FB1}) to reduce the V_{OUT} leakage current to 40 - 200kΩ, typically. There is no strict requirement on the feedback resistor. $R_{FB1} > 10kΩ$ is reasonable for most applications. R_{FB2} can be calculated with Equation. The values for trim resistors shown in trim tables below are according to standard E96 values; therefore, the specified voltage may slightly vary.

Feedback Network

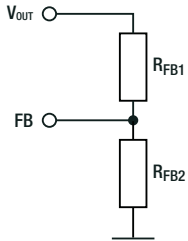

Calculation:

$$R_{FB2} = \frac{R_{FB1}}{\frac{V_{OUT}}{0.6} - 1}$$

Practical example with $V_{OUT} = 1.8VDC$

$$R_{FB2} = \frac{82k\Omega}{\frac{1.8}{0.6} - 1} = 41k2\Omega$$

Table below lists recommended resistor values for common V_{OUT} :

V_{OUT} [VDC]	R_{FB1} [Ω]	R_{FB2} [Ω]
1.0	56k2	84k5
1.2	82k	82k
1.8		41k2
2.5		26k1
3.3		18k

TYPICAL PERFORMANCE CHARACTERISTICS (measured @ $T_{AMB} = 25^{\circ}C$, $V_{OUT} = 1.2VDC$)

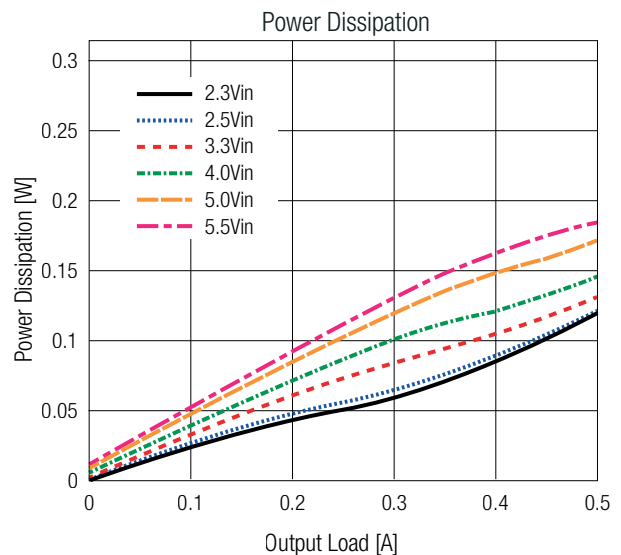
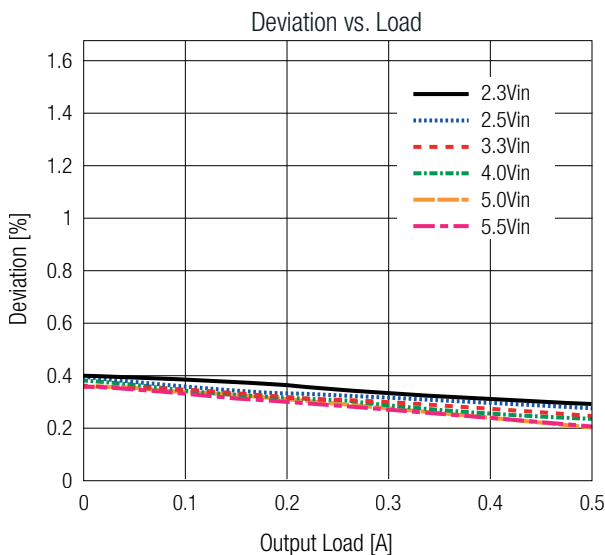
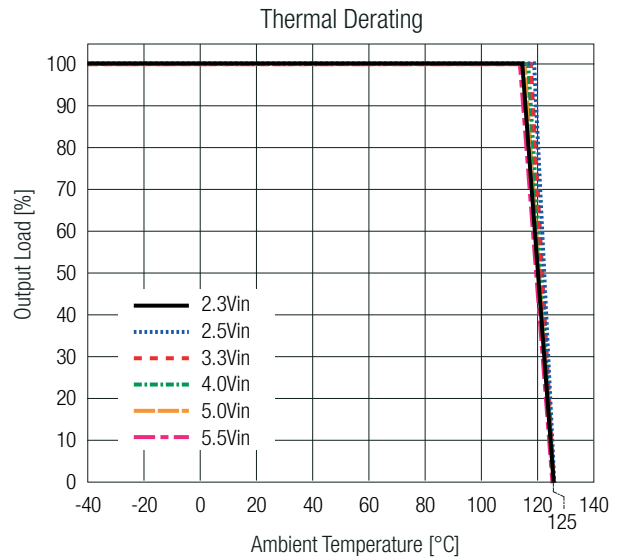
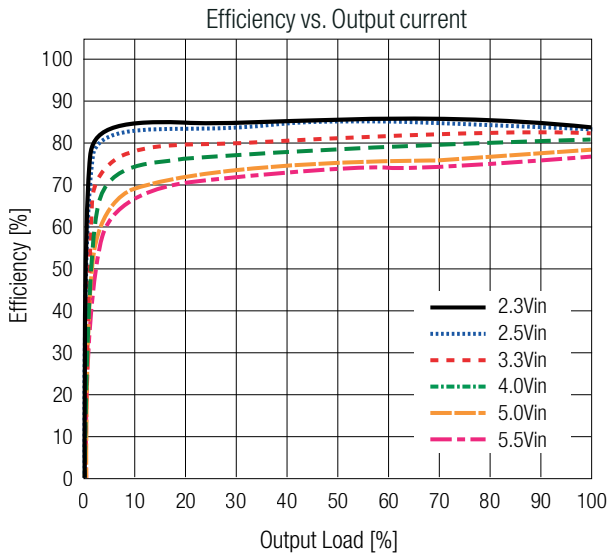

RPZ-0.5 Series / Power Module

0.5 Amp / 2.3-5.5VDC / 10 Pad QFN Package

TYPICAL PERFORMANCE CHARACTERISTICS (measured @ $T_{AMB} = 25^{\circ}C$, $V_{OUT} = 3.3VDC$)

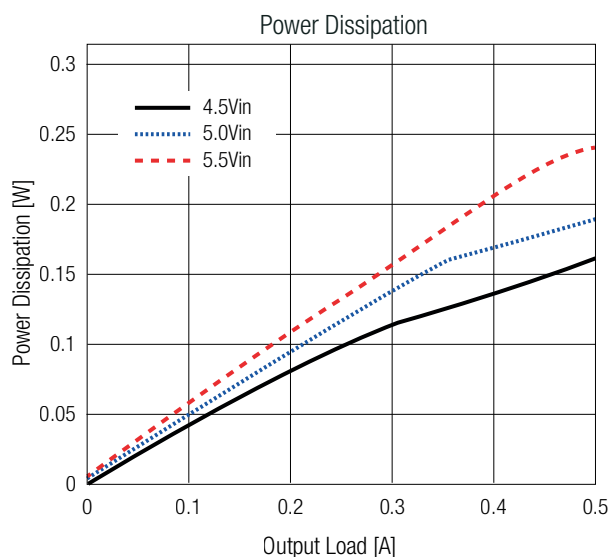
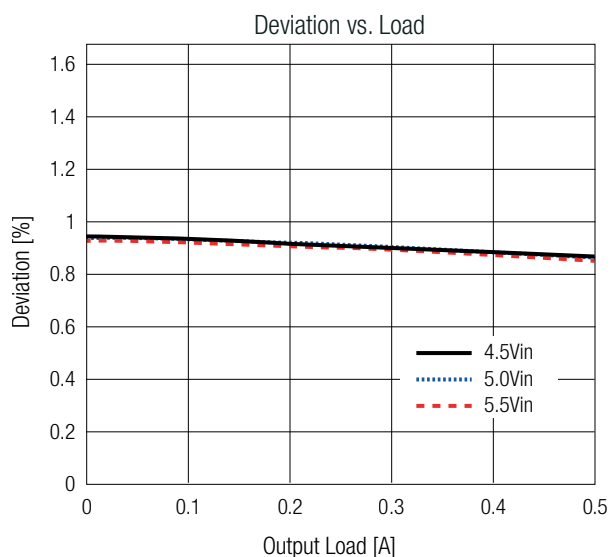
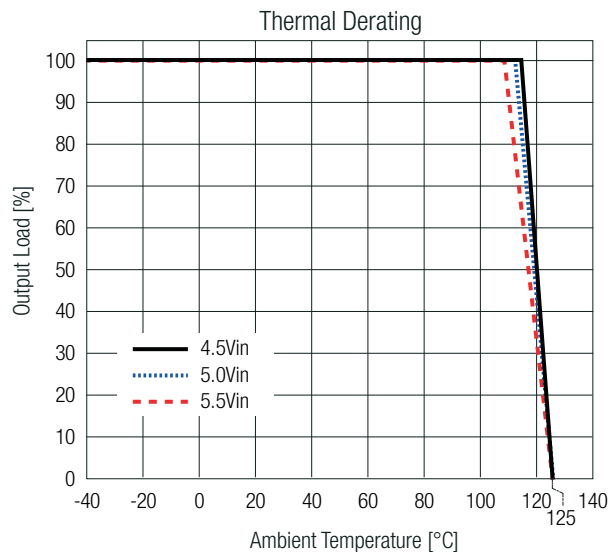
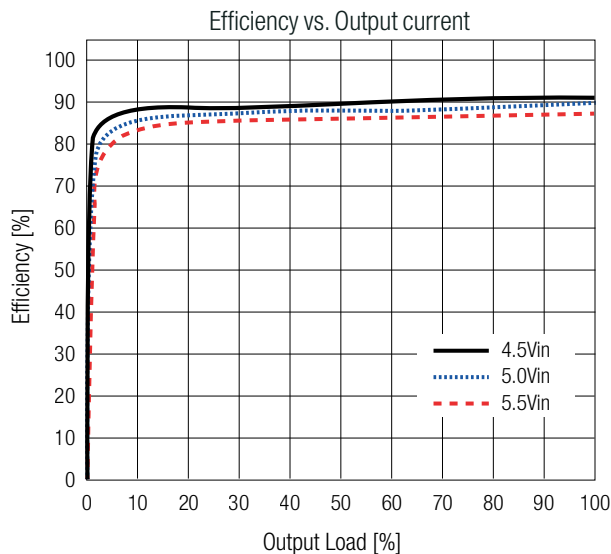

SAFETY & CERTIFICATIONS

Certificate Type (Safety)	Report Number	Standard
RoHS2		RoHS 2011/65EU + AM2015/863

DIMENSION & PHYSICAL CHARACTERISTICS

Parameter	Type	Value
Material	case	plastic
Dimension (LxWxH)		2.0 x 2.0 x 1.6mm 0.079 x 0.079 x 0.063inch
Weight		0.1g typ. 0.0002lbs

DIMENSION & PHYSICAL CHARACTERISTICS

Dimension Drawing (mm)

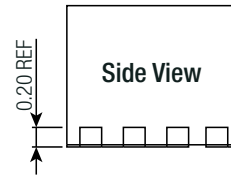
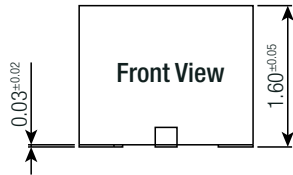
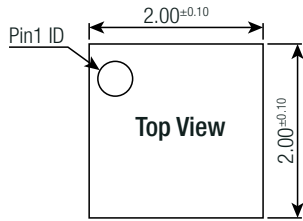
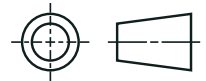

Bottom View

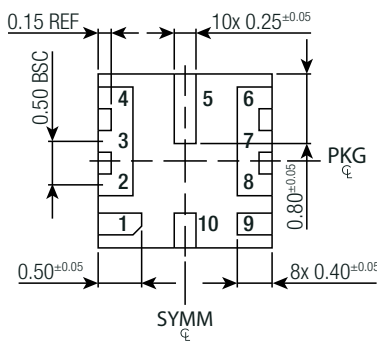

Recommended Footprint Details (Top View)

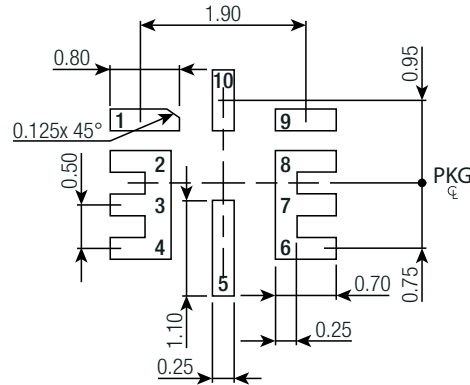

Pad Information

Pad #	Function	Description
1	V _{IN}	Supply Voltage. The RPZ-0.5 operates from a +2.3V to +5.5V unregulated input range. A decoupling capacitor is needed to prevent large voltage spikes from appearing at the input.
2 - 4	SW	Output switching node.
5	CTRL	On/off Control.
6 - 8	V _{OUT}	Output voltage power rail and input sense pin for output voltage. Connect the load to OUT. An output capacitor is needed at OUT to decrease the output voltage ripple.
9	FB	Feedback. An external resistor divider from the output to GND tapped to FB sets the output voltage.
10	GND	Power ground.

Tolerances:
 x.x= ±0.1mm
 x.xx= ±0.05mm

RPZ-0.5 Series / Power Module

0.5 Amp / 2.3-5.5VDC / 10 Pad QFN Package



PACKAGING INFORMATION

Parameter	Type	Value
Packaging Dimension (LxWxH)	Suffix -R: tape & reel (diameter)	Ø330.2
	tape and reel (carton)	355.6 x 355.6 x 50.8mm
	Suffix -CT: moisture barrier bag	100 x 100 x 30mm
Packaging Quantity	Suffix -R: tape & reel	500pcs
	Suffix -CT: moisture barrier bag	10pcs
Tape Width		12mm
Storage Temperature Range		-65°C to +150°C
Storage Humidity	non-condensing	60% RH max.

The product information and specifications may be subject to changes even without prior written notice. The product has been designed for various applications; its suitability lies in the responsibility of each customer. The products are not authorized for use in safety-critical applications without RECOM's explicit written consent. A safety-critical application is an application where a failure may reasonably be expected to endanger or cause loss of life, inflict bodily harm or damage property. The applicant shall indemnify and hold harmless RECOM, its affiliated companies and its representatives against any damage claims in connection with the unauthorized use of RECOM products in such safety-critical applications.