

# RPZ-3.0A Series / Power Module

3.0 Amp / 2.75-6.0VDC / 18 Pad QFN Package

## FEATURES

- Buck regulator with integrated shielded inductor
- 6V maximum input voltage
- Programmable 0.6 - 5.5V output voltage
- 3A maximum output current
- SCP, OCP, OTP, and UVLO protection
- 2.5mm x 3.5mm x 1.6mm QFN package
- Efficiency up to 92%
- 3 year warranty



Dimensions (LxWxH): 2.5 x 3.5 x 1.6mm (0.098 x 0.137 x 0.063inch)  
0.1g (0.0002lbs)

## APPLICATIONS

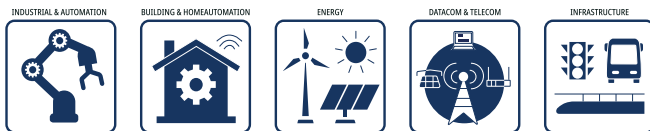

## SAFETY & EMC



## DESCRIPTION

Introducing the RPZ-3.0A, the latest innovation in non-isolated step-down power modules. This compact powerhouse redefines expectations with its cutting-edge features and compact design, making it an ideal choice for applications demanding efficiency, reliability, and space optimization such as portable electronics, IoT devices, embedded systems, industrial automation, and for powering microcontrollers and sensors. The RPZ-3.0A is a buck regulator power module that incorporates an integrated shielded inductor, ensuring optimal performance in a variety of settings. With a maximum input voltage of 6V, this module is designed for efficiency and size, offering a stable and reliable power conversion solution for low-voltage applications. Flexibility is at the core of the RPZ-3.0A, allowing for programmable output voltages ranging from 0.6V to 5.5V. Delivering up to 3A of maximum output current, the RPZ-3.0A is engineered to power a variety of electronic devices and systems efficiently. Safety is paramount, and this module comes equipped with Short Circuit Protection (SCP), Overcurrent Protection (OCP), Overtemperature Protection (OTP), and Undervoltage Lockout (UVLO) features, ensuring the longevity and protection of connected devices. Housed in an incredibly compact 2.5mm x 3.5mm x 1.6mm QFN package, the RPZ-3.0A is designed to maximize space efficiency without compromising performance. The integration of Flip-Chip technology enhances thermal management, ensuring the module operates at peak efficiency even in demanding conditions. With an impressive efficiency rating of up to 92%, the RPZ-3.0A not only meets but exceeds industry standards. This high efficiency not only minimizes energy consumption but also reduces heat generation, contributing to the overall reliability and extended lifespan of the module. The RPZ-3.0A is a non-isolated step-down power module that combines compact design, versatility, and advanced thermal management for a reliable and efficient power solution in a minimal footprint.

## SELECTION GUIDE

Part Number	Input Voltage Range [VDC]	Output Voltage Range [VDC]	Output Current max. [mA]	Efficiency <sup>(1)</sup> typ. [%]
RPZ-3.0A	2.75 - 6.0	0.6 - 5.5	3000	92

Note1: Efficiency is tested at  $V_{in} = 3.6VDC$ ,  $V_{out} = 1.2VDC$  full load at +25°C ambient

## MODEL NUMBERING

**RPZ-3.0A-** \_\_\_\_\_  
 Output Current \_\_\_\_\_ Packaging <sup>(2)</sup>

Note2: Add suffix "-R" for tape and reel packaging  
 Add suffix "-CT" for bag packaging (refer to „Packaging information“)

# RPZ-3.0A Series / Power Module

3.0 Amp / 2.75-6.0VDC / 18 Pad QFN Package

## ABSOLUTE MAXIMUM RATINGS

Parameter	Symbol	Condition	Min.	Typ.	Max.
Absolute maximum voltage	$V_{SW}$		-0.3VDC		6.5VDC
		others	-0.3VDC		6.5VDC
Maximum continuous power losses <sup>(3)</sup>		$T_{AMB} = +25^{\circ}C$			3W
Junction Temperature	$T_J$				+150°C
Lead Temperature					+260°C

Note3: Exceeding maximum allowable power dissipation causes device to enter thermal shutdown which protects device from permanent damage.

## BASIC CHARACTERISTICS (measured @ $T_{AMB} = 25^{\circ}C$ , nom. $V_{IN}$ , full load and after warm-up unless otherwise stated)

Parameter	Symbol	Condition	Min.	Typ.	Max.
Input Voltage Range	$V_{IN}$	refer to „Safe Operating Area“	2.75VDC		6VDC
Under Voltage Lockout UVLO			2.3VDC	2.5VDC	2.75VDC
Under Voltage Lockout Hysteresis				400mV	
Quiescent current	$I_Q$	$V_{CTRL} = 2VDC, V_{FB} = 0.63VDC$		500µA	
Recommended Input Capacitance		$V_{IN} = 3.6VDC, V_{OUT} = 1.2VDC, I_{OUT} = 2A$	4.7µF	22µF	
Output Capacitance		$V_{IN} = 3.6VDC, V_{OUT} = 1.2VDC, I_{OUT} = 2A$	10µF	22µF	100µF
Output Voltage Range	$V_{OUT}$	refer to „Safe Operating Area“	0.6VDC		5.5VDC
Standby current	$I_{IN}$	$V_{CTRL} = 0VDC, T_J = 25^{\circ}C$		0µA	1µA
Feedback voltage	$V_{FB}$	$2.75VDC \leq V_{IN} \leq 6VDC$	591mV	600mV	609mV
Feedback current	$I_{FB}$	$V_{FB} = 0.6VDC$		10nA	
High Side MosFet Peak Current Limit			3.6A	6A	
Low Side Valley Current Limit				1.5A	
Internal Inductor L Value	L	Inductance value at 1MHz		1µH	
Dropout resistance	$R_{DR}$	100% on duty		130mΩ	
Output Ripple		$V_{OUT} = 1.2VDC, I_{OUT} = 2000mA, C_{OUT} = 22µF$		5mV	
Load transient peak-to-peak voltage		$C_{OUT} = 22µF, I_{OUT} = 0$ to 2000mA @1A/µs			100mV
Minimum On Time				80ns	
Minimum Off Time				230ns	
On time	$T_{ON}$	$V_{IN} = 5VDC, V_{OUT} = 1.2VDC$		185ns	
		$V_{IN} = 3.6VDC, V_{OUT} = 1.2VDC$		250ns	

### Typical Application

$V_{IN} = 2.75-6VDC, V_{OUT} = 1.2VDC, I_{OUT} = 3A$

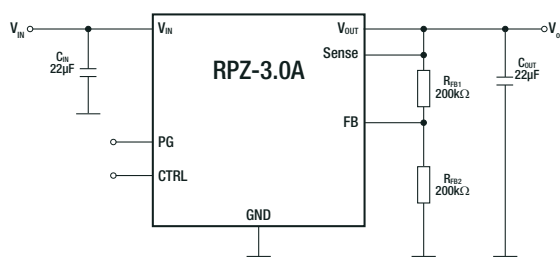

### Safe Operating Area

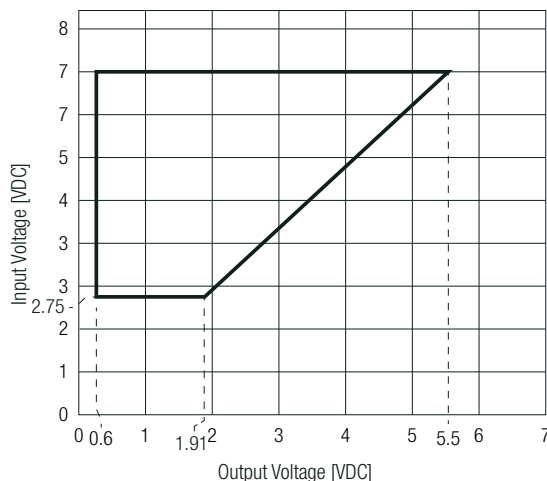

# RPZ-3.0A Series / Power Module

3.0 Amp / 2.75-6.0VDC / 18 Pad QFN Package



## CTRL OPERATING CONDITIONS

Parameter	Condition	Min.	Typ.	Max.
CTRL input logic low voltage				0.3VDC
CTRL input logic high voltage		1.2VDC		
CTRL input current	$V_{CTRL} = 2VDC$		2 $\mu$ A	
	$V_{CTRL} = 0VDC$		0 $\mu$ A	

## POWER GOOD OPERATING CONDITIONS

Parameter	Condition	Min.	Typ.	Max.
UV threshold			-10%	
OV threshold			10%	
Delay			100 $\mu$ s	
Sink current capability	sink current 1mA			0.4VDC
Logic high voltage	$V_{IN} = 5VDC, V_{FB} = 0.6VDC$	4VDC		
Internal pull-up resistor			440k $\Omega$	

## SWITCHING CHARACTERISTICS

Parameter	Symbol	Condition	Min.	Typ.	Max.
Switching Frequency	$f_{sw}$	$V_{OUT} = 1.2VDC, I_{OUT} = 1000mA$		1150kHz	
Switch leakage		$V_{CTRL} = 0VDC, V_{IN} = 6VDC, V_{SW} = 0VDC$ and 6VDC		0 $\mu$ A	2 $\mu$ A

## PROTECTIONS

Parameter	Condition	Value	
Short Circuit Protection SCP		hiccup, auto recovery	
Over Current Protection OCP		>6A typ., hiccup, auto recovery	
Thermal shutdown	restart after cooldown	junction temperature	160°C typ.
		hysteresis	30°C typ.

## THERMAL OPERATING CONDITIONS (measured @ $T_{AMB} = 25^\circ C$ , nom. $V_{IN}$ , full load and after warm-up unless otherwise stated)

Parameter	Symbol	Condition	Min.	Typ.	Max.
Operating Junction Temperature	$T_J$	refer to „Thermal Derating“	-40°C		+125°C
Thermal Resistance <sup>(4)</sup>	$R_{thJA}$	junction to ambient			42K/W
	$R_{thJC}$	junction to case			13K/W

Note4: Test PCB= 6.4 x 6.4cm double sided PCB with 20oz copper, natural convection

## ENVIRONMENTAL

Parameter	Condition	Value
Moisture Sensitive Level		Level 3, 245°C, 168hrs

### OUTPUT VOLTAGE SETTING

The RPZ-3.0A series offers the feature of trimming the output voltage by using external trim resistors (see „**Typical Application**“). The external resistor divider is used to set the output voltage. The feedback resistor ( $R_{FB1}$ ) cannot be too large or too small considering the trade-off for stability and dynamics. There is no strict requirement for the feedback resistor.  $R_{FB2}$  can be calculated with Equation. Typically, setting the current through  $R_{FB2}$  to less than 250µA provides a good balance between system stability and minimal load loss. Then  $R_{FB1}$  can be calculated with Equation. The values for trim resistors shown in trim tables below are according to standard E96 values; therefore, the specified voltage may slightly vary.

#### Feedback Network

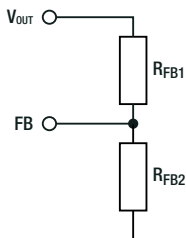

#### Calculation:

$$R_{FB2} = \frac{R_{FB1}}{\frac{V_{OUT}}{0.6} - 1}$$

#### Practical example with $V_{OUT} = 1.8VDC$

$$R_{FB2} = \frac{200k\Omega}{\frac{1.8}{0.6} - 1} = 100k\Omega$$

Table below lists recommended resistor values for common  $V_{OUT}$ :

$V_{OUT}$ [VDC]	$R_{FB1}$ [ $\Omega$ ]	$R_{FB2}$ [ $\Omega$ ]
1.0	200k	300k
1.2		200k
1.8		100k
2.5		63k2
3.3		44k2

### TYPICAL PERFORMANCE CHARACTERISTICS (measured @ $T_{AMB} = 25^\circ C, V_{OUT} = 1.2VDC$ )

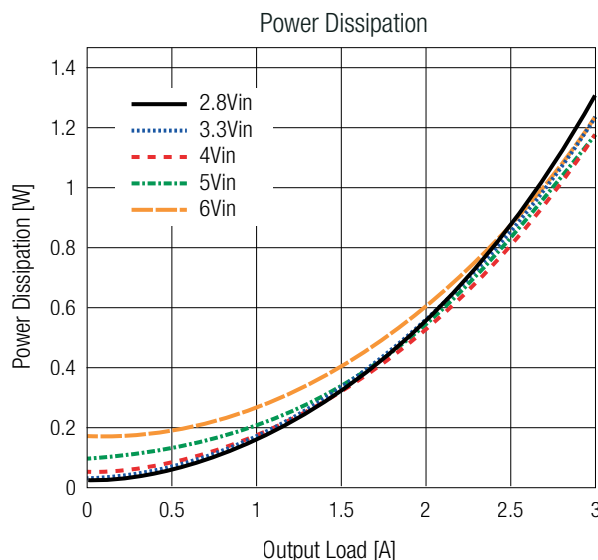
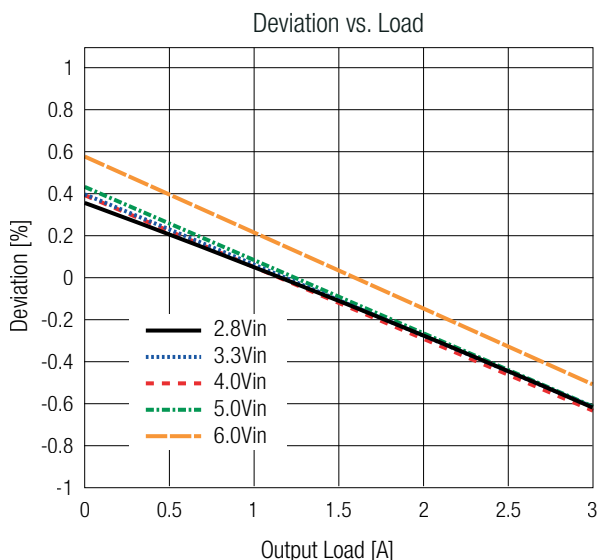
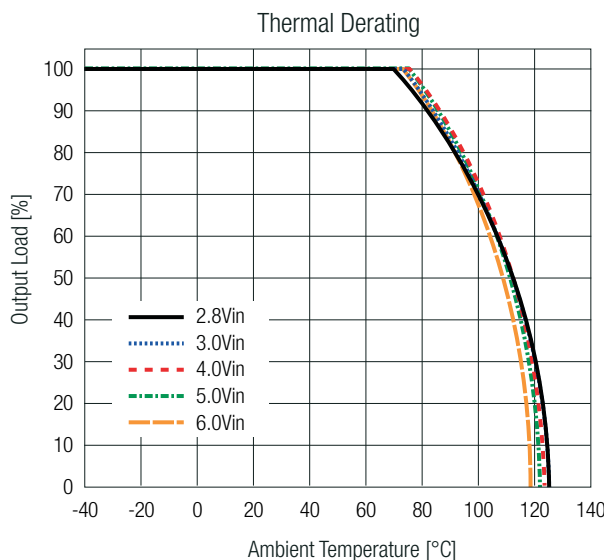
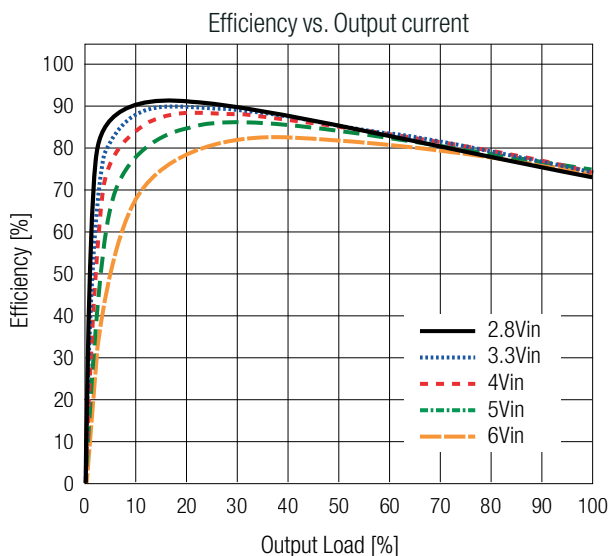

# RPZ-3.0A Series / Power Module

3.0 Amp / 2.75-6.0VDC / 18 Pad QFN Package

TYPICAL PERFORMANCE CHARACTERISTICS (measured @  $T_{AMB} = 25^{\circ}C$ ,  $V_{OUT} = 3.3VDC$ )

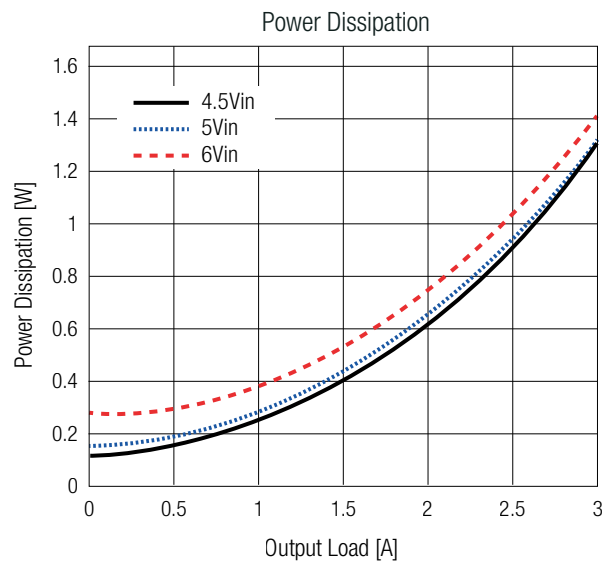
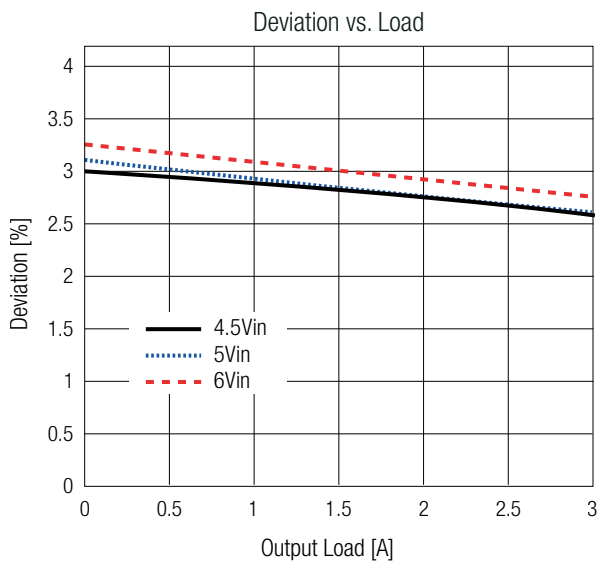
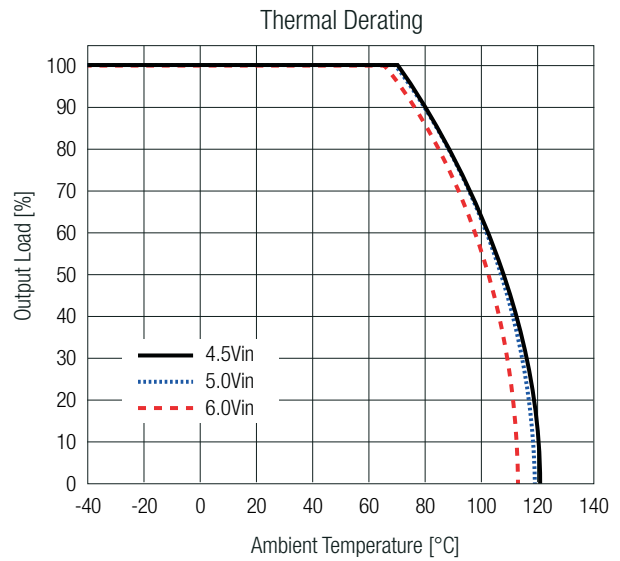
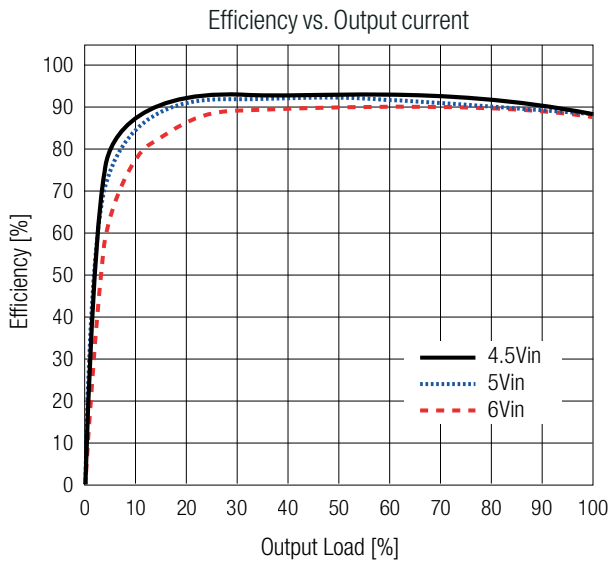

## SAFETY & CERTIFICATIONS

Certificate Type (Safety)	Report Number	Standard
RoHS2		RoHS 2011/65EU + AM2015/863

## DIMENSION & PHYSICAL CHARACTERISTICS

Parameter	Type	Value
Material	case	plastic
Dimension (LxWxH)		2.5 x 3.5 x 1.6mm 0.098 x 0.137 x 0.063inch
Weight		0.1g typ. 0.0002lbs

### DIMENSION & PHYSICAL CHARACTERISTICS

Dimension Drawing (mm)

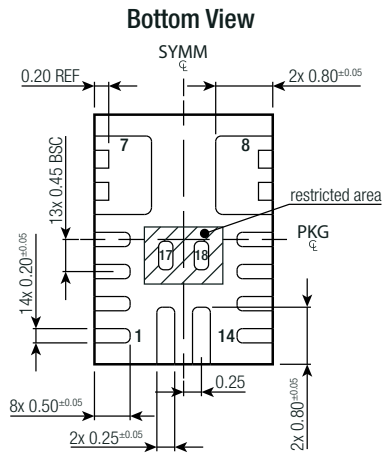
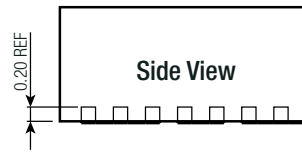
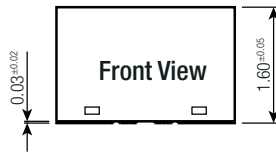
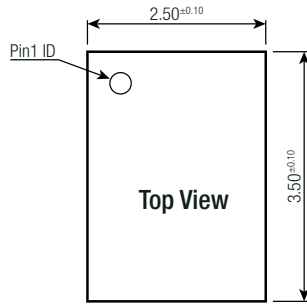
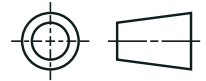

Recommended Footprint Details (Top View)

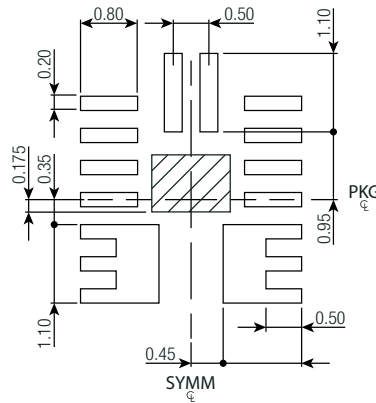

### Pad Information

Pad #	Function	Description
1	AGND	Analog ground for the internal control circuit
2	FB	Feedback. Use an external resistor divider from the output to GND tapped to FB to set the output voltage
3	SENSE	Output voltage sense
4	CTRL	On/off control
5-7, 15	SW	Switch output
8-10	V <sub>OUT</sub>	Power Output
11	NC	Do not connect this pin. Leave floating.
12	PG	Power good indicator. The output of PG is an open drain with an internal pull-up resistor to IN. PG is pulled up to IN when the FB voltage is within 10% of the regulation level; otherwise, PG is low.
13, 14	V <sub>IN</sub>	Supply Voltage. The RPZ-2.0 operates from a +2.75V to +6V unregulated input range. A decoupling capacitor is needed to prevent large voltage spikes from appearing at the input.
16	PGND	Power Ground
17, 18	DNC	No connection. Leave DNC floating

Tolerances:  
 x.x= ±0.1mm  
 x.xx= ±0.05mm

# RPZ-3.0A Series / Power Module

3.0 Amp / 2.75-6.0VDC / 18 Pad QFN Package



## PACKAGING INFORMATION

Parameter	Type	Value
Packaging Dimension (LxWxH)	Suffix -R: tape & reel (diameter)	Ø330.2
	tape and reel (carton)	355.6 x 355.6 x 50.8mm
Packaging Quantity	Suffix -CT: moisture barrier bag	100 x 100 x 30mm
	Suffix -R: tape & reel	500pcs
Tape Width	Suffix -CT: moisture barrier bag	10pcs
		12mm
Storage Temperature Range		-65°C to +150°C
Storage Humidity	non-condensing	60% RH max.

The product information and specifications may be subject to changes even without prior written notice. The product has been designed for various applications; its suitability lies in the responsibility of each customer. The products are not authorized for use in safety-critical applications without RECOM's explicit written consent. A safety-critical application is an application where a failure may reasonably be expected to endanger or cause loss of life, inflict bodily harm or damage property. The applicant shall indemnify and hold harmless RECOM, its affiliated companies and its representatives against any damage claims in connection with the unauthorized use of RECOM products in such safety-critical applications.